

AS A227T flush mounted floor profile is applicable to all types of floors and load bearing capacity is designed for heavy vehicles or cars depending on the gap inquired. Pure metal structure characterizes AS A227 T as a hardwearing & maintenance free profile and makes it ideal for the places with heavy pedestrian traffic. Round-headed articulated design enables the profile to meet displacements in 3 directions. AS A227 T differs from AS A227 with monoblock base frame design. Profiles are delivered factory - assembled and for wide gaps soft EPDM tape is placed on the center plate to align the distance between the side frames. For surface mounted applications AS U237 model is available.

- Application Areas** : Indoor & Outdoor / Floor
- Ideal for** : Factories, Warehouses, Car Parks, Airports, Shopping Malls, Hospitals, Commercial & Public Buildings etc.
- Material** : Mill Finish Aluminum (Anodizing optional), Soft EPDM tape
- Aluminum Alloy** : 6063 AA-USA / EN AW 6063
- Optional Supplies** : Fire Barrier, Waterproof EPDM membrane

FLOOR

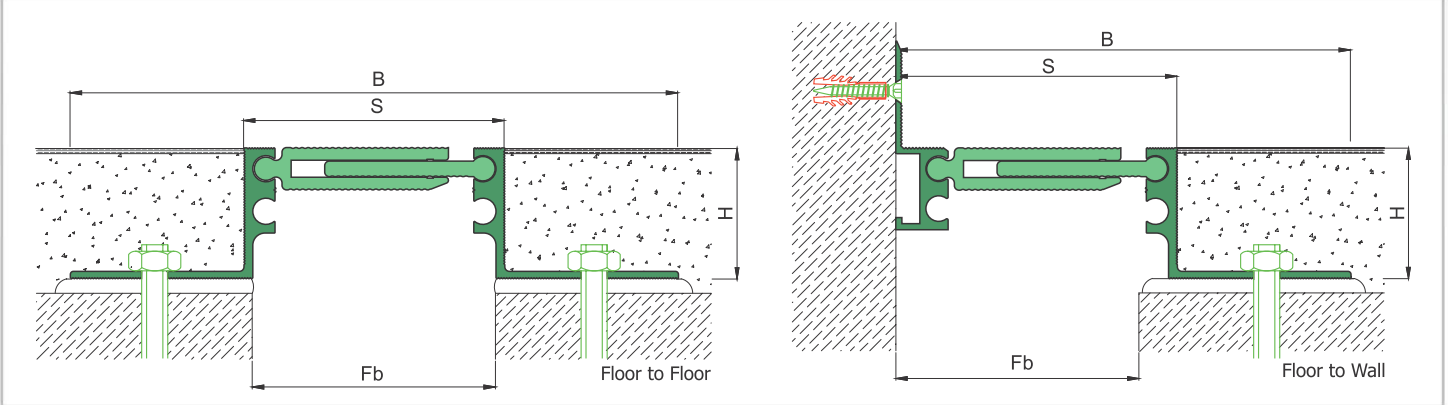
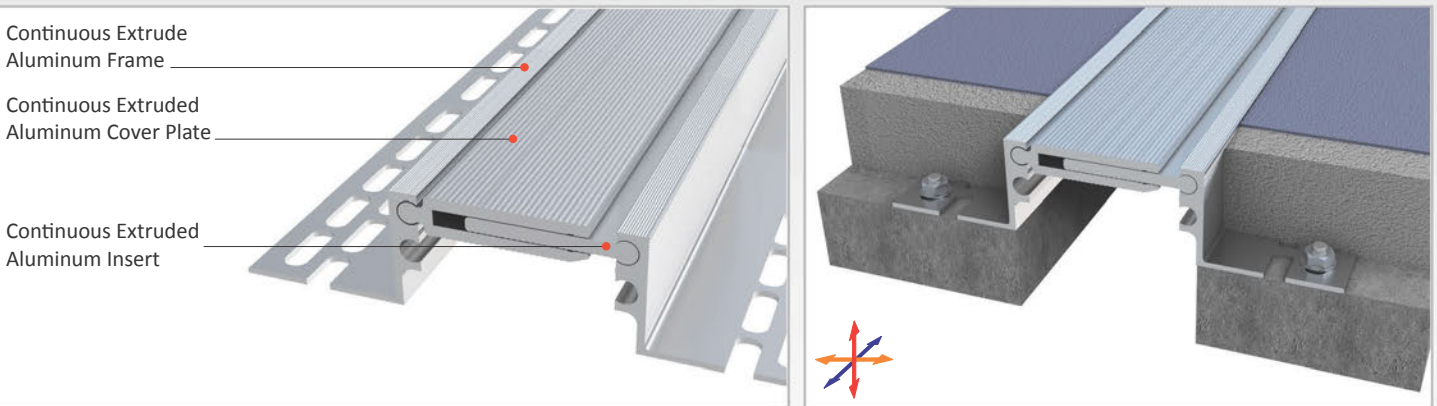

* Visuals are representative and the profile configuration may differ depending on the characteristics requested.

LOCATION	MODEL	GAP (Fb) mm	HEIGHT (H) MM	OVERALL WIDTH (B) mm	VISIBLE WIDTH (S) mm	MOVEMENT (W) mm	LOAD CAPACITY	STANDARD LENGTH (mt)
Floor to Floor	AS A227T-050	50	35 / 43 / 60	174	60	± 6	35 kN 120 kN	3
	AS A227T-080	80	35 / 43 / 60	200	85	± 8	25 kN 60 kN	3
	AS A227T-100	100	35 / 43 / 60	220	105	± 16		3
	AS A227T-120	120	35 / 43 / 60	240	126	± 10		3
	AS A227T-150	150	35 / 43 / 60	270	155	± 18		3
	AS A227T-180	180	35 / 43 / 60	300	185	± 18		3
	AS A227T-200	200	35 / 43 / 60	320	205	± 20		3

Note: Please ask for different sizes



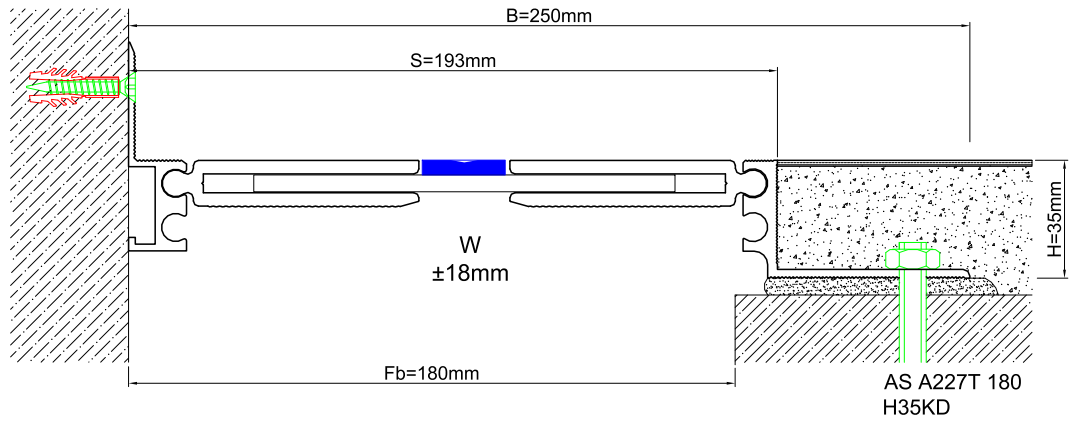
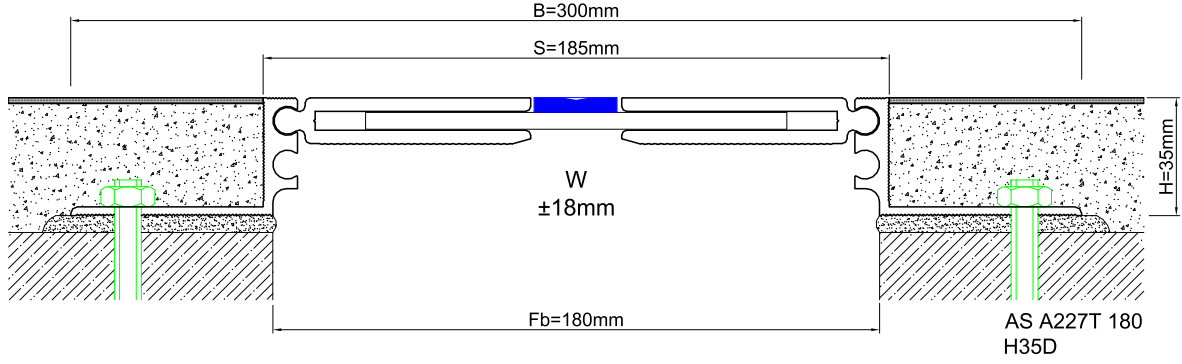

Profil No Profile Number	AS A227T 180	AS A227T 180K
Fb (mm)	180	180
H (mm) yaklaşık approx.	35	35
W± (mm) yaklaşık approx.	±18	±18
Renk Color	Alüminyum: Natürel Aluminum: Natural	
Malzeme Material	Alüminyum Aluminum	
Standart Uzunluk Standard Length	3	
Yükleme Kapasitesi Load-Bearing Capacity	